

■ Features

- 4"x2" miniature size
- Universal AC input / Full range
- Built-in active PFC function
- EMI Class B for both Class I (with FG) and Class II (without FG) configuration
- Medical safety approved (2 x MOPP between primary to secondary)
- Suitable for BF application with appropriate system consideration
- Low leakage current <math>< 190\mu\text{A}</math>
- No load power consumption <math>< 0.5\text{W}</math>
- High efficiency up to 94%
- Protections: Short circuit / Overload / Over voltage / Over temperature
- Cooling by free air convection for 140W and 200W with 10CFM forced air
- Built-in 12V/0.5A fan supply
- LED indicator for power on
- 3 years warranty

■ Applications

- Oral irrigator
- Hemodialysis machine
- Medical monitors
- Sleep apnea devices
- Pumps machine
- Electric bed

■ Description

RPS-200 is a 200W highly reliable green PCB type medical power supply with a high power density (21.9W/in³) on the 4" by 2" footprint. It accepts 80~264VAC input and offers various output voltages between 12V and 48V. The working efficiency is up to 94% and the extremely low no load power consumption is down below 0.5W. RPS-200 is able to be used for both Class I (with FG) and Class II (no FG) system design. The extremely low leakage current is less than 190μA. In addition, it conforms to the international medical regulations (2*MOPP) and EMC EN55011, perfectly fitting all kinds of BF rated "patient contact" medical system equipment.

■ Model Encoding

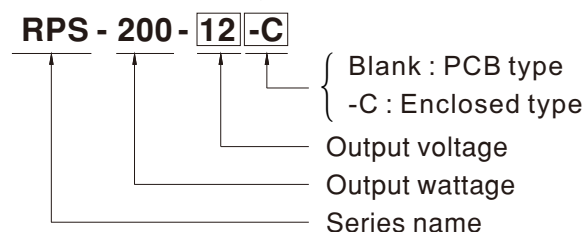



SPECIFICATION

| MODEL | | RPS-200-12□ | RPS-200-15□ | RPS-200-24□ | RPS-200-27□ | RPS-200-48□ | |
|-----------------------|---|---|--------------|--------------|--------------|--------------|--------|
| OUTPUT | DC VOLTAGE | 12V | 15V | 24V | 27V | 48V | |
| | CURRENT | 10CFM | 16.7A | 13.4A | 8.4A | 7.5A | 4.2A |
| | | Convection | 11.7A | 9.4A | 5.9A | 5.3A | 3A |
| | RATED POWER | 10CFM | 200.4W | 201W | 201.6W | 202.5W | 201.6W |
| | | Convection | 140.4W | 141W | 141.6W | 143.1W | 144W |
| | RIPPLE & NOISE (max.) Note.2 | 100mVp-p | 100mVp-p | 150mVp-p | 150mVp-p | 200mVp-p | |
| | VOLTAGE ADJ. RANGE | 11.4~12.6V | 14.3~15.8V | 22.8~25.2V | 25.6 ~ 28.4V | 45.6 ~50.4V | |
| | VOLTAGE TOLERANCE Note.3 | ±2.0% | ±2.0% | ±1.0% | ±1.0% | ±1.0% | |
| | LINE REGULATION | ±0.5% | ±0.5% | ±0.5% | ±0.5% | ±0.5% | |
| | LOAD REGULATION | ±1.0% | ±1.0% | ±1.0% | ±1.0% | ±1.0% | |
| SETUP, RISE TIME | 700ms, 30ms/230VAC 700ms, 30ms/115VAC at full load | | | | | | |
| HOLD UP TIME (Typ.) | 12ms/230VAC 12ms/115VAC at full load | | | | | | |
| INPUT | VOLTAGE RANGE Note.4 | 80 ~ 264VAC 113 ~ 370VDC | | | | | |
| | FREQUENCY RANGE | 47 ~ 63Hz | | | | | |
| | POWER FACTOR | PF>0.94/230VAC PF>0.98/115VAC at full load | | | | | |
| | EFFICIENCY (Typ.) | 93% | 93% | 94% | 94% | 94% | |
| | AC CURRENT (Typ.) | 2A/115VAC 1A/230VAC | | | | | |
| | INRUSH CURRENT (Typ.) | COLD START 30A/115VAC | | 60A/230VAC | | | |
| | LEAKAGE CURRENT Note.5 | Earth leakage current < 190µA/264VAC , Touch current < 100µA/264VAC | | | | | |
| PROTECTION | OVERLOAD | 110 ~ 140% rated output power Protection type : Hiccup mode, recovers automatically after fault condition is removed | | | | | |
| | OVER VOLTAGE | 13.2 ~ 15.6V | 16.5 ~ 19.5V | 26.4 ~ 31.2V | 29.7 ~ 35V | 52.8 ~ 62.4V | |
| | OVER TEMPERATURE | Protection type : Shut down o/p voltage, re-power on to recover | | | | | |
| FUNCTION | FAN SUPPLY | 12V@0.5A for driving a fan ; tolerance +15% ~ -15% | | | | | |
| ENVIRONMENT | WORKING TEMP. | -30 ~ +70°C (Refer to "Derating Curve") | | | | | |
| | WORKING HUMIDITY | 20 ~ 90% RH non-condensing | | | | | |
| | STORAGE TEMP., HUMIDITY | -40 ~ +85°C, 10 ~ 95% RH | | | | | |
| | TEMP. COEFFICIENT | ±0.03%/°C (0 ~ 50°C) | | | | | |
| | VIBRATION | 10 ~ 500Hz, 2G 10min./1cycle, 60min. each along X, Y, Z axes | | | | | |
| SAFETY & EMC (Note 6) | SAFETY STANDARDS | ANSI/AAMI ES60601-1, TUV EN60601-1, IEC60601-1 approved | | | | | |
| | ISOLATION RESISTANCE | Primary-Secondary: 2xMOPP, Primary-Earth:1xMOPP, Secondary-Earth:1xMOPP | | | | | |
| | WITHSTAND VOLTAGE | I/P-O/P:4KVAC I/P-FG:2KVAC O/P-FG:1.5KVAC | | | | | |
| | ISOLATION RESISTANCE | I/P-O/P, I/P-FG:100M Ohms / 500VDC / 25°C / 70% RH | | | | | |
| | EMC EMISSION | Compliance to EN55011 (CISPR11) Class B, EN61000-3-2,-3 | | | | | |
| OTHERS | EMC IMMUNITY | Compliance to EN61000-4-2,3,4,5,6,8,11, EN55024, EN60601-1-2, medical level, criteria A | | | | | |
| | MTBF | 500.2Khrs min. MIL-HDBK-217F (25°C) | | | | | |
| | DIMENSION | PCB:101.6*50.8*29mm (L*W*H) ; Enclosed type:103.4*62*40mm (L*W*H) | | | | | |
| | PACKING | PCB:0.19Kg; 72pcs/14.7Kg/0.82CUFT ; Enclosed type:0.3Kg; 60pcs/19Kg/1.12CUFT | | | | | |
| NOTE | <p>1. All parameters NOT specially mentioned are measured at 230VAC input, rated load and 25 of ambient temperature.</p> <p>2. Ripple & noise are measured at 20MHz of bandwidth by using a 12" twisted pair-wire terminated with a 0.1uf & 47uf parallel capacitor.</p> <p>3. Tolerance : includes set up tolerance, line regulation and load regulation.</p> <p>4. Derating may be needed under low input voltages. Please check the derating curve for more details.</p> <p>5. Touch current was measured from primary input to DC output.</p> <p>6. The power supply is considered a component which will be installed into a final equipment. All the EMC tests are been executed by mounting the unit on a 360mm*360mm metal plate with 1mm of thickness. The final equipment must be re-confirmed that it still meets EMC directives. For guidance on how to perform these EMC tests, please refer to "EMI testing of component power supplies." (as available on http://www.meanwell.com)</p> | | | | | | |

Block Diagram

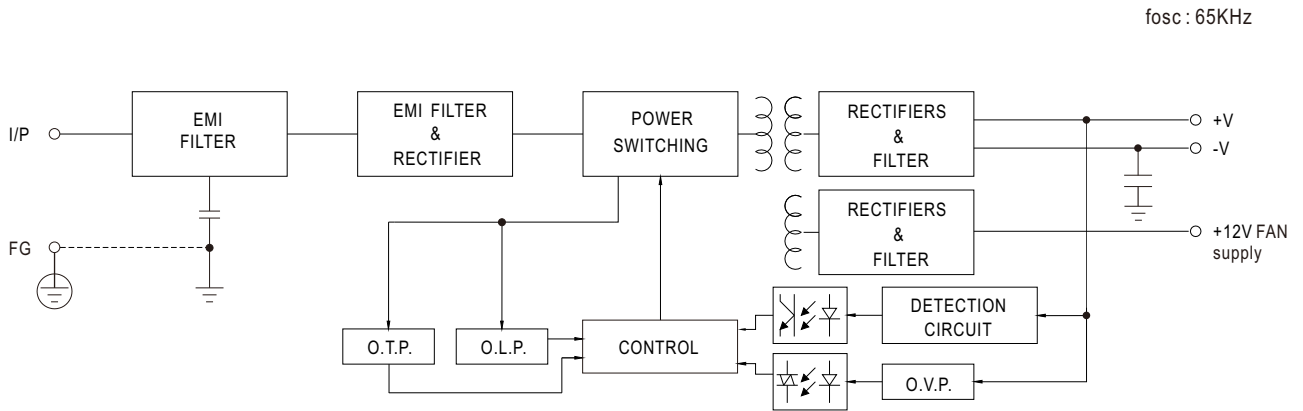

Derating Curve

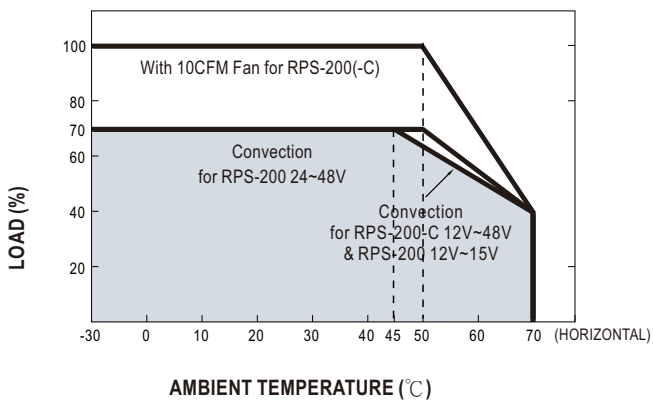

Output Derating VS Input Voltage

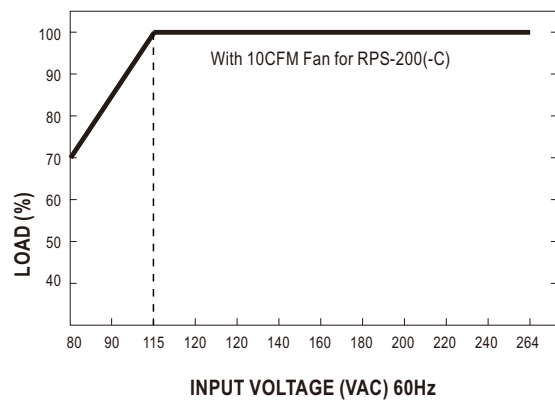

Case No.245A Unit:mm

Mechanical Specification

○ PCB type

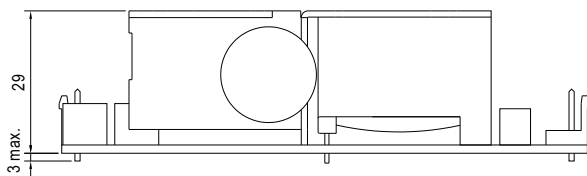
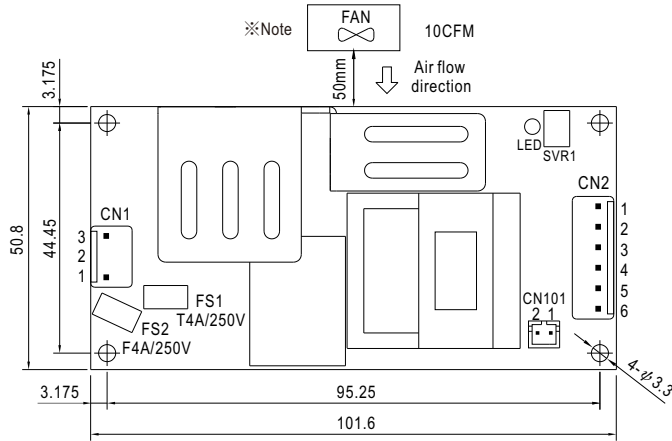

AC Input Connector (CN1) : JST B3P-VH or equivalent

| Pin No. | Assignment | Mating Housing | Terminal |
|---------|------------|-----------------------|--------------------------------|
| 1 | AC/L | JST VHR or equivalent | JST SVH-21T-P1.1 or equivalent |
| 2 | No Pin | | |
| 3 | AC/N | | |

DC Output Connector (CN2) : JST B6P-VH or equivalent

| Pin No. | Assignment | Mating Housing | Terminal |
|---------|------------|-----------------------|--------------------------------|
| 1,2,3 | +V | JST VHR or equivalent | JST SVH-21T-P1.1 or equivalent |
| 4,5,6 | -V | | |

FAN Connector(CN101) : JST B2B-PH-K-S or equivalent

| Pin No. | Assignment | Mating Housing | Terminal |
|---------|------------|-------------------------|----------------------------------|
| 1 | DC COM | JST PHR-2 or equivalent | JST SPH-002T-P0.5S or equivalent |
| 2 | +12V | | |

- ※Note : 1. The FAN supply is designed to serve as the source of the additive external fan for the cooling of the power supply, enabling the full load delivery and assuring the best life span of the product. Please do not use this FAN supply to drive other devices.
 2.The PCB type(Blank type)model delivers EMI Class B for both conducted emission and radiated emission for the power supply, when configured into either Class I (with FG) or Class II (without FG) system.
 3.The Enclosed type(-C type) model is not suitable for the configuration within a Class II (without FG) system but is suggested to used within a Class I (with FG) system.

○ Enclosed type

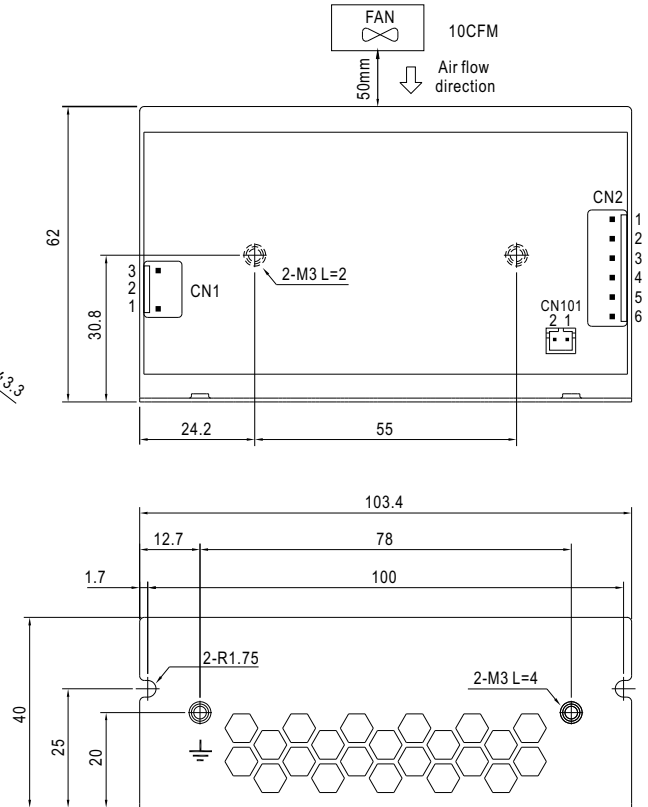

Installation Manual

Please refer to : <http://www.meanwell.com/webnet/search/InstallationSearch.html>